

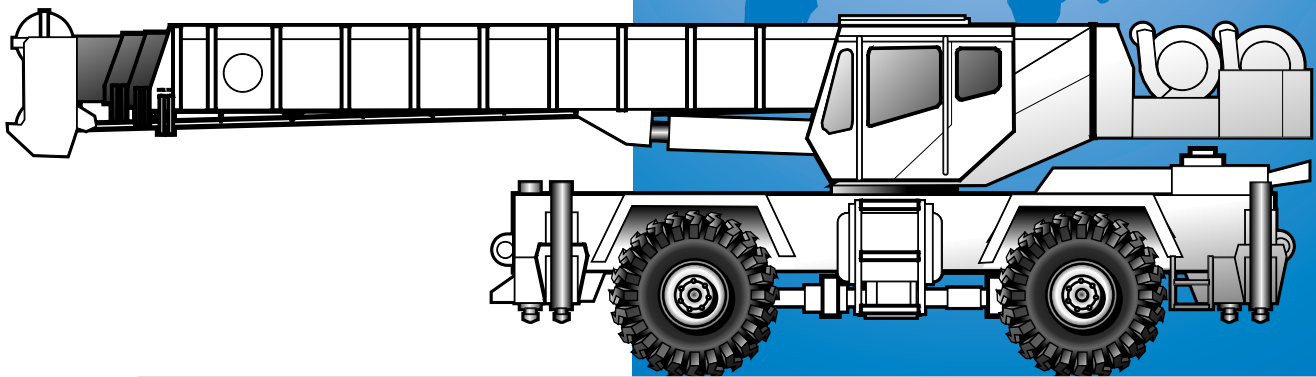

# RT635C



**Rough Terrain Hydraulic Crane**

# Dimensions

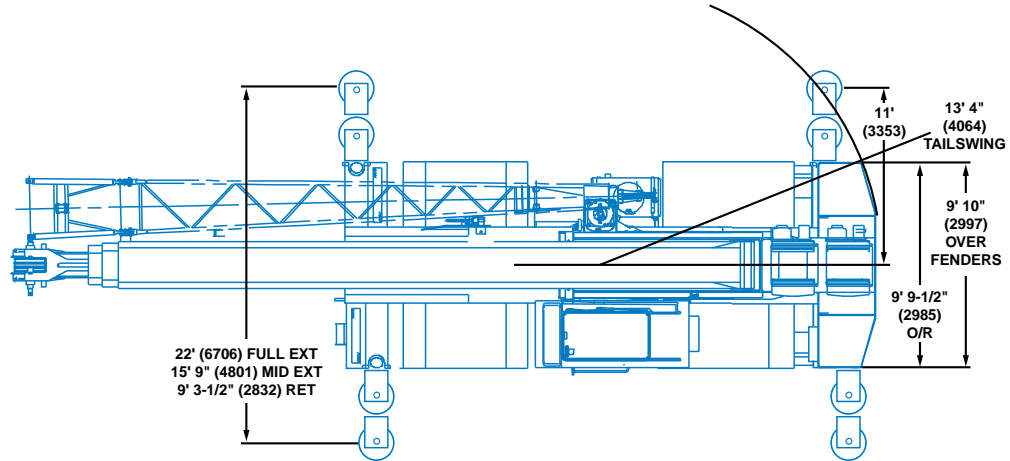

	Tire Size	
	23.5 x 25	26.5 x 25
A	5' 4-1/4" (1631)	5' 5-1/2" (1661)
B	11' 11-1/2" (3645)	12' 2-1/4" (3715)
C	10' 10-3/4" (3323)	11' (3353)
D	1' 9-3/4" (553)	1' 4-1/4" (413)
E	1' 6-1/4" (464)	1' 7-1/2" (495)
F	5-3/4" (146)	1' 3-1/4" (387)
G	1' 3-1/4" (387)	9-3/4" (248)
H	24.6°	20°

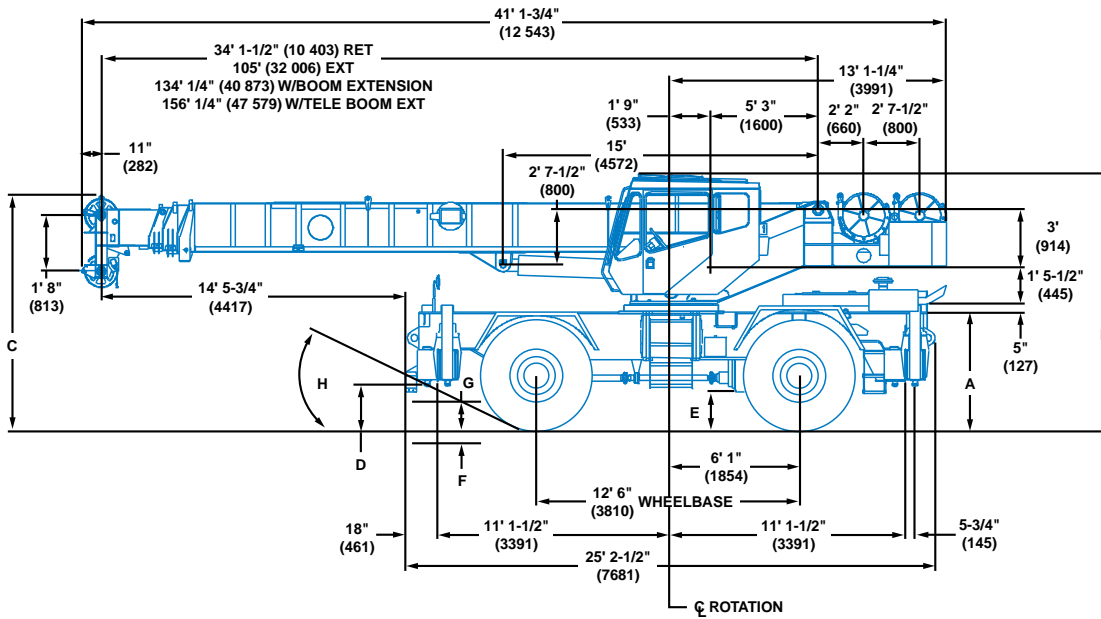

Note: ( ) Reference dimensions in mm

- Turning Radius . . . . . 20' (6096 mm) (23.5 Tires)
- Front Axle Load . . . . . 32,961 lbs. (14 951 kg)
- Rear Axle Load . . . . . 31,881 lbs. (14 461 kg)
- Gross Vehicle Weight . . . . . 64,842 lbs. (29 412 kg)

# Working range

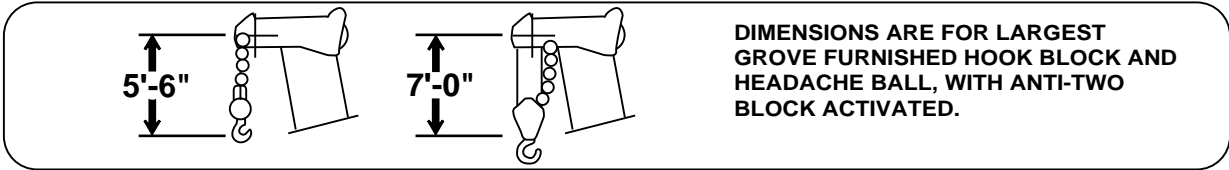
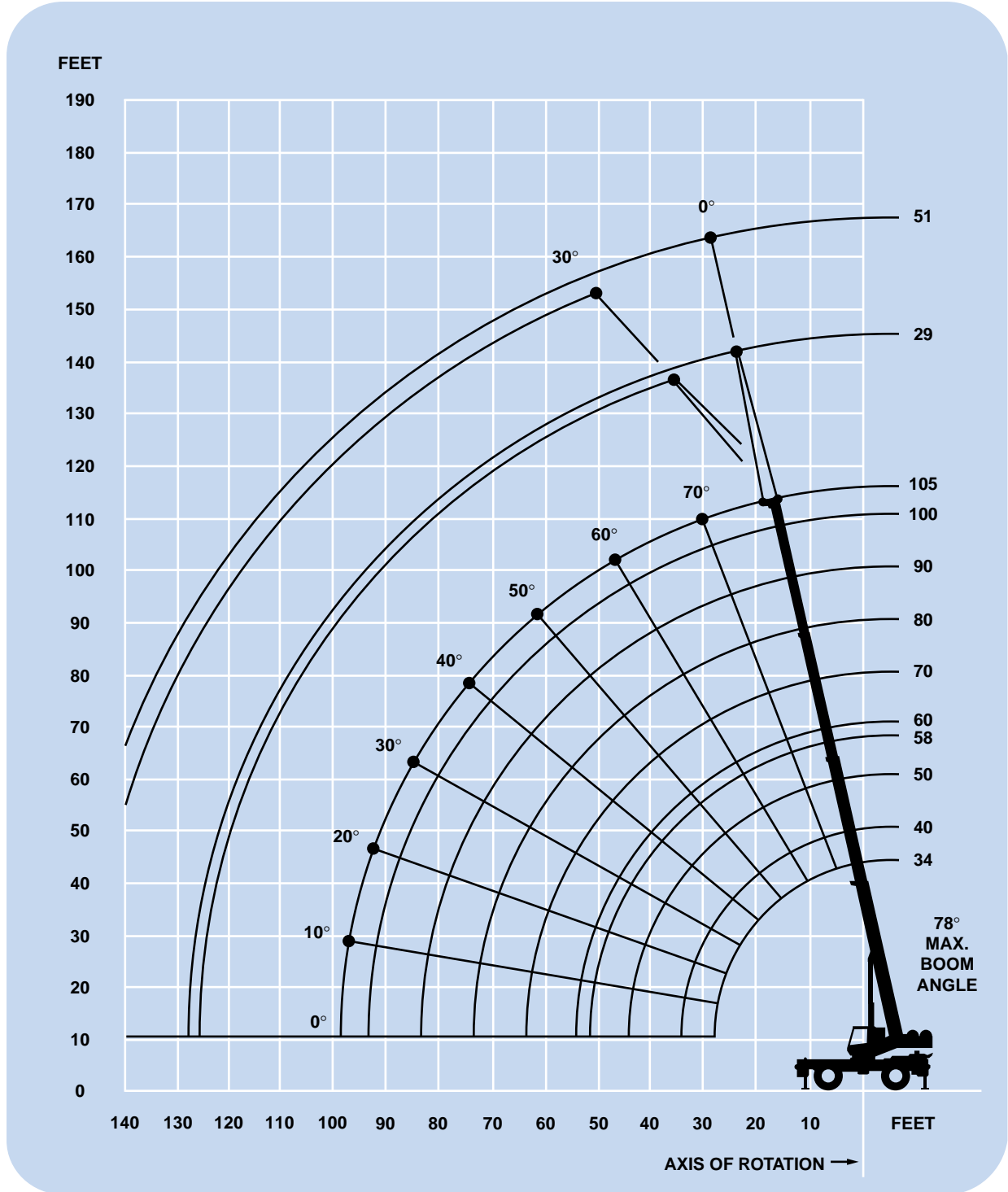
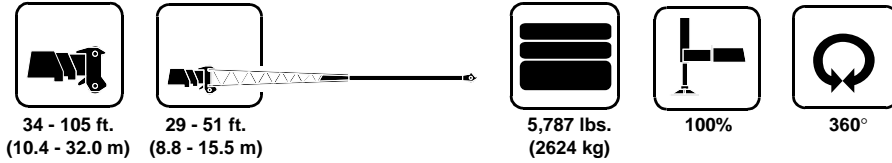

# Superstructure specifications

## Boom

34 ft. - 105 ft. (10.4 m - 32.0 m) four-section full power boom. Maximum tip height: 112 ft. (34.0 m).

## Fixed Lattice Extension

29 ft. (8.8 m) lattice swingaway extension. Offsettable at 0° and 30°. Stows alongside base boom section. Maximum tip height: 141 ft. (43.0 m).

## \*Optional Telescopic Swingaway Extension

29 ft. - 51 ft. (8.8 m - 15.5 m) telescoping lattice swingaway extension. Offsettable at 0° or 30°. Stows alongside base boom section. Maximum tip height: 162 ft. (49.3 m).

## Boom Nose

Three steel sheaves mounted on heavy duty tapered roller bearings with removable pin-type rope guards. Quick reeve type boom nose. \*Optional removable auxiliary boom nose with removable pin type rope guard.

## Boom Elevation

One double acting hydraulic cylinder with integral holding valve provides elevation from -3° to +78°.

## Load Moment & Anti-Two Block System

Standard load moment and anti-two block system with audio-visual warning and control lever lock-out. These systems provide electronic display of boom angle, length, radius, tip height, relative load moment, maximum permissible load, load indication and warning of impending two-block condition.

## Cab

Full vision all steel fabricated with acoustical lining and tinted safety glass throughout. Deluxe seat incorporates armrest mounted hydraulic single-axis controllers. Dash panel incorporates gauges for engine functions. Other standard features include: hydraulic oil heater, telescoping tilt wheel, sliding side and rear windows, opening skylight, skylight sunscreen, electric windshield wash/wipe, electric skylight wiper, fire extinguisher, seat belt and ashtray.

## Swing

Planetary swing with foot applied multi-disc wet brake. Spring applied, hydraulically released swing brake and plunger-type, 1 position, mechanical house lock, operated from cab. 360° mechanical swing lock. Maximum speed: 2.5 RPM.

## Counterweight

5,787 lbs. (2624 kg) integral with superstructure. 1,900 lbs. (861 kg) slab in place of auxiliary hoist.

## HYDRAULIC SYSTEM

Four main gear pumps with a combined capacity of 119 GPM (451 LPM). Pump disconnect with engine jogging switch.

Three individual valve banks.

Return line type filter with full flow by-pass protection and service indicator. Replaceable cartridge with micron filtration rating of 5/12/16.

103 gallon (390 L) reservoir.

Remote-mounted oil cooler with thermostatically controlled electric motor driven fan.

System pressure test ports with quick release type fittings for each circuit.

## HOIST SPECIFICATIONS

### Main and Auxiliary Hoists

Planetary reduction with automatic spring applied multi-disc brake. Grooved drum. Electronic hoist drum rotation indicator, hoist drum cable followers and wire rope.

	<u>High</u>	<u>Low</u>
Maximum Single Line Pull:	8,254 lbs. (3744 kg)	16,508 lbs. (7488 kg)
Maximum Single Line Speed:	580 FPM (177 m/min)	306 FPM (93 m/min)
Maximum Permissible Line Pull:	12,920 lbs. (5860 kg)	12,920 lbs. (5860 kg)
Rope Diameter:	3/4" (19 mm)	
Rope Length:	450 ft. (137 m)	
Maximum Rope Stowage:	690 ft. (210 m)	

*\*Denotes optional equipment*

# Carrier specifications

## Chassis

Box section frame fabricated from high-strength, low alloy steel. Integral outrigger housings and front/rear towing and tie down lugs.

## Outriggers System

Four hydraulic telescoping single-stage double box beam outriggers with inverted jacks and integral holding valves. Three position setting. All steel fabricated quick release type outrigger floats, 24 in. (610 mm) in diameter.  
Maximum outrigger pad load: 47,604 lbs. (21 593 kg).

## Outrigger Controls

Controls and crane level indicator located in cab.

## Engine

Cummins 6BT5.9 diesel, six cylinders, turbocharged, 152 bhp (113 kW) (Gross) @ 2,500 RPM.  
Maximum torque: 400 ft. lbs. (536 N.m) @ 1,600 RPM.

## \*Optional Engine

Caterpillar 3116T diesel, six cylinders, turbocharged, 160 bhp (119 kW) (Gross) @ 2,500 RPM.  
Maximum torque: 441 ft. lbs. (591 N.m) @ 1,650 RPM.

## Fuel Tank Capacity

60 gallons (227 L).

## Transmission

Full powershift with 6 forward and 3 reverse speeds.  
Rear axle disconnect for 4 x 2 travel.

## Electrical System

Two 12 V maintenance free batteries.  
12 V starting and lighting.

## Drive

4 x 4.

## Steering

Full independent power steering.  
Front: Full hydraulic steering wheel controlled.  
Rear: Full hydraulic hand lever controlled.  
Provides infinite variations of 4 main steering modes: front only, rear only, crab and coordinated. Rear steer indicating gauge.

## Axles

Front: Drive/steer with differential and planetary reduction hubs rigid mounted to frame.  
\*Optional no-spin differential.  
Rear: Drive/steer with differential and planetary reduction hubs pivot mounted to frame.

## Oscillation Lockouts

Automatic full hydraulic lockouts on rear axle permit oscillation only with boom centered over the front.

## Brakes

Full hydraulic split circuit disc-type brakes operating on all wheels. Spring-applied hydraulically released front axle-mounted parking brake.

## Tires

23.5R25 radial earthmover type, tubeless.  
\*26.5 x 25 - 26PR bias, earthmover type, tubeless.

## Lights

Full lighting package including turn indicators, head, tail, brake and hazard warning lights.

## Maximum Speed

24 mph (39 kph).

## Gradeability (Theoretical)

74% (Based on 63,151 lbs. [28 645 kg] GVW), 23.5R25 tires, pumps disengaged, 105 ft. (32.0 m) boom and 29 ft. - 51 ft. (8.8 m - 15.5 m) swingaway.

## Miscellaneous Standard Equipment

Full width steel fenders, dual rear view mirrors, hook-block tiedown, electronic back-up alarm, light package, front stowage well, tachometer, cold start aid (less canister), rear wheel position indicator, hydraulic oil heater, hoist mirrors, engine distress A/V warning system. Auxiliary hoist control valve arrangement (less hoist), 360° positive swing lock.

## Optional Equipment

*Auxiliary hoist	*Spare wheel assembly
*Boom mounted worklights	*Tool kit
*360° flashing light	*Pintle hook front/rear
*Cab spotlight	*High Speed Glide System
*Engine block heater	*Air conditioning
*Hookblocks (quick reeve type)	*Dual axis joystick controller
*Tow winch - front mounted - maximum pull: 15,000 lbs. (6804 kg); maximum speed: 92 ft./min. (28 m/min)	*LMI light bar (internal or external)
	*Emergency steer pump
	*Auxiliary hydraulic oil cooler

*\*Denotes optional equipment*

## ***Weight Reductions for Load Handling Devices***

### **29 ft. (8.8 m) Fixed Lattice Boom Extension with 34 ft. - 105 ft. (10.4 - 32 m) Boom**

*Stowed	421 lbs.	(191 kg)
*Erected	2,875 lbs.	(1304 kg)

### **29 ft. - 51 ft. (8.8 m - 15.5 m) Tele Boom Extension with 34 ft. - 105 ft. (10.4 - 32 m) Boom**

*Stowed	641 lbs.	(291 kg)
*Erected (Retracted)	4,378 lbs.	(1986 kg)
*Erected (Extended)	6,628 lbs.	(3006 kg)

\*Reduction of main boom capacities:

When lifting over swingaway and/or jib combinations, deduct total weight of all load handling devices reeved over main boom nose directly from swingaway or jib capacity.

NOTE: All load handling devices and boom attachments are considered part of the load and suitable allowances **MUST BE MADE** for their combined weights. Weights are for Grove furnished equipment.

Auxiliary Boom Head	143 lbs.	(65 kg)
---------------------	----------	---------

Hookblocks and Headache Balls:

+ 35 ton, 3 sheave	872 lbs.	(396 kg)
+ 35 ton, 3 sheave w/cheekplates	1,065 lbs.	(483 kg)
+ 15 ton, 1 sheave	380 lbs.	(172 kg)
+ 10 ton headache ball	560 lbs.	(254 kg)

+ Refer to rating plate for actual weight.



34 - 105 ft.  
(10.4 - 32.0 m)



5,787 lbs.  
(2624 kg)



100%



360°



Pounds

Feet	34	40	50	*58	60	70	80	90	100	105
10	70,000 (66)	66,900 (70)	58,650 (74.5)	44,600 (76.5)	29,300 (77)					
12	68,050 (62)	64,100 (67)	55,000 (72)	44,600 (74.5)	29,300 (75)	29,300 (78)				
15	59,150 (55.5)	57,650 (62)	48,000 (68.5)	41,500 (71.5)	29,300 (72.5)	29,300 (75.5)				
20	45,900 (43.5)	45,450 (52.5)	38,500 (61.5)	35,900 (66)	29,300 (67.5)	29,300 (72)	29,300 (75)	27,000 (77)		
25	35,550 (26.5)	35,250 (42)	32,400 (54.5)	30,500 (60.5)	29,300 (62.5)	27,950 (67.5)	26,350 (71)	23,250 (74)	18,550 (75.5)	@15,850 (76.5)
30		27,150 (27.5)	26,500 (46.5)	25,550 (54)	25,300 (56.5)	24,000 (62.5)	22,950 (67)	20,300 (70.5)	16,500 (72.5)	15,850 (74)
35			19,550 (37.5)	19,150 (47.5)	19,350 (50)	20,250 (57.5)	20,000 (63)	17,950 (67)	14,800 (69.5)	14,350 (71)
40			15,000 (24.5)	14,650 (39.5)	14,850 (43)	15,650 (52.5)	16,450 (58.5)	16,000 (63)	13,400 (66.5)	12,850 (68)
45				11,500 (30)	11,650 (34.5)	12,400 (46.5)	13,100 (54)	13,450 (59)	12,500 (63)	11,550 (64.5)
50				9,180 (13.5)	9,330 (23)	10,000 (40)	10,650 (49)	10,950 (55)	11,300 (59.5)	10,400 (61.5)
55						8,170 (32)	8,770 (43.5)	9,080 (51)	9,390 (56)	9,450 (58)
60						6,710 (21.5)	7,250 (37.5)	7,560 (46)	7,870 (52)	8,020 (54.5)
65							6,020 (30.5)	6,320 (41)	6,630 (48)	6,790 (51)
70							4,990 (20.5)	5,300 (35)	5,610 (43.5)	5,760 (47)
75								4,450 (28.5)	4,750 (38.5)	4,890 (42.5)
80								3,740 (18.5)	4,020 (33.5)	4,150 (38)
85									3,390 (26.5)	3,510 (32.5)
90									2,830 (18)	2,950 (26)
95										2,460 (17.5)

Minimum boom angle (deg.) for indicated length

0

Maximum boom length (ft.) at 0 deg. boom angle (no load)

105

NOTE: ( ) Boom angles are in degrees.

\*58 ft. boom length is with inner-mid extended and outer-mid & fly retracted.

@ Capacity also applicable at maximum boom angle.

A6-829-011360A

Boom Angle	34	40	50	*58	60	70	80	90	100	105
0°	16,350 (27.1)	12,700 (33)	8,390 (43)	6,030 (50.8)	5,710 (53)	4,380 (63)	3,370 (73)	2,590 (83)	1,960 (93)	1,700 (98)

NOTE: ( ) Reference radii in feet.

\*58 ft. boom length is with inner-mid extended and outer-mid & fly retracted.

A6-829-011625



34 - 105 ft.  
(10.4 - 32.0 m)



5,787 lbs.  
(2624 kg)



50%  
15' 9" Spread



360°



Pounds

Feet	34	40	50	*58	60	70	80	90	100	105
10	70,000 (66)	66,900 (70)	58,650 (74.5)	44,600 (76.5)	29,300 (77)					
12	64,350 (62)	64,000 (67)	55,000 (72)	44,600 (74.5)	29,300 (75)	29,300 (78)				
15	54,050 (55.5)	53,550 (62)	48,000 (68.5)	41,500 (71.5)	29,300 (72.5)	29,300 (75.5)				
20	35,000 (43.5)	33,350 (52.5)	30,850 (61.5)	29,350 (66)	29,250 (67.5)	28,900 (72)	28,400 (75)	27,000 (77)		
25	23,150 (26.5)	22,700 (42)	21,500 (54.5)	20,450 (60.5)	20,500 (62.5)	20,550 (67.5)	20,450 (71)	20,250 (74)	18,550 (75.5)	@15,850 (76.5)
30		16,000 (27.5)	15,500 (46.5)	15,050 (54)	15,150 (56.5)	15,350 (62.5)	15,450 (67)	15,400 (70.5)	15,350 (72.5)	15,250 (74)
35			11,400 (37.5)	11,050 (47.5)	11,200 (50)	11,850 (57.5)	12,000 (63)	12,100 (67)	12,100 (69.5)	12,100 (71)
40			8,590 (24.5)	8,310 (39.5)	8,450 (43)	9,050 (52.5)	9,540 (58.5)	9,680 (63)	9,750 (66.5)	9,770 (68)
45				6,290 (30)	6,420 (34.5)	6,990 (46.5)	7,550 (54)	7,820 (59)	7,930 (63)	7,970 (64.5)
50				4,740 (13.5)	4,870 (23)	5,410 (40)	5,960 (49)	6,330 (55)	6,490 (59.5)	6,540 (61.5)
55						4,210 (32)	4,700 (43.5)	5,050 (51)	5,330 (56)	5,390 (58)
60						3,240 (21.5)	3,680 (37.5)	4,010 (46)	4,340 (52)	4,430 (54.5)
65							2,850 (30.5)	3,160 (41)	3,470 (48)	3,620 (51)
70							2,140 (20.5)	2,440 (35)	2,750 (43.5)	2,900 (47)
75								1,840 (28.5)	2,130 (38.5)	2,270 (42.5)
80								1,330 (18.5)	1,600 (33.5)	1,730 (38)
85									1,140 (26.5)	1,270 (32.5)

Minimum boom angle (deg.) for indicated length

26

Maximum boom length (ft.) at 0 deg. boom angle (no load)

90

NOTE: ( ) Boom angles are in degrees.

@Capacity also applicable at maximum boom angle.

Boom Angle	34	40	50	*58	60	70	80	90
0°	16,350 (27.1)	12,700 (33)	7,280 (43)	4,550 (50.8)	4,140 (53)	2,740 (63)	1,770 (73)	1,060 (83)

NOTE: ( ) Reference radii in feet.

\*58 ft. boom length is with inner-mid extended and outer-mid & fly retracted.

A6-829-012055A





34 - 105 ft.  
(10.4 - 32.0 m)



5,787 lbs.  
(2624 kg)



0%  
9' 3-1/2" Spread



360°



Pounds

Feet	34	40	50	*58	60	70	80	90	100	105
10	47,200 (66)	44,100 (70)	39,900 (74.5)	37,150 (76.5)	29,300 (77)					
12	36,100 (62)	33,900 (67)	30,900 (72)	28,950 (74.5)	28,800 (75)	28,000 (78)				
15	24,700 (55.5)	24,250 (62)	22,450 (68.5)	21,100 (71.5)	21,100 (72.5)	20,850 (75.5)				
20	15,050 (43.5)	14,650 (52.5)	14,200 (61.5)	13,050 (66)	13,200 (67.5)	13,750 (72)	13,750 (75)	13,650 (77)		
25	10,050 (26.5)	9,660 (42)	8,950 (54.5)	8,400 (60.5)	8,530 (62.5)	9,120 (67.5)	9,720 (71)	9,780 (74)	9,760 (75.5)	9,740 (76.5)
30		6,270 (27.5)	5,880 (46.5)	5,570 (54)	5,690 (56.5)	6,230 (62.5)	6,780 (67)	7,170 (70.5)	7,240 (72.5)	7,260 (74)
35			3,930 (37.5)	3,680 (47.5)	3,790 (50)	4,300 (57.5)	4,800 (63)	5,190 (67)	5,410 (69.5)	5,460 (71)
40			2,540 (24.5)	2,320 (39.5)	2,430 (43)	2,910 (52.5)	3,390 (58.5)	3,740 (63)	4,030 (66.5)	4,090 (68)
45				1,300 (30)	1,400 (34.5)	1,860 (46.5)	2,320 (54)	2,650 (59)	2,950 (63)	3,020 (64.5)
50						1,050 (40)	1,500 (49)	1,800 (55)	2,080 (59.5)	2,160 (61.5)
55								1,120 (51)	1,370 (56)	1,450 (58)

Minimum boom angle (deg.) for indicated length

55.5

Maximum boom length (ft.) at 0 deg. boom angle (no load)

50

NOTE: ( ) Boom angles are in degrees.

\*58 ft. boom length is with inner-mid extended and outer-mid & fly retracted.

@Capacity also applicable at maximum boom angle.

Boom Angle	34	40	50
0°	8,090 (27.1)	4,980 (33)	1,880 (43)

NOTE: ( ) Reference radii in feet.

\*58 ft. boom length is with inner-mid extended and outer-mid & fly retracted.

A6-829-012056

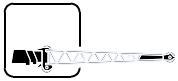

29 ft.  
(8.8 m)



5,787 lbs.  
(2624 kg)



100%



360°



Feet	0° OFFSET	30° OFFSET
30	9,360 (77.5)	
35	8,960 (75.5)	
40	8,610 (73)	*5,360 (78)
45	7,860 (71)	5,160 (75.5)
50	7,210 (68.5)	4,960 (73.5)
55	6,610 (66)	4,760 (71)
60	5,960 (64)	4,710 (68.5)
65	5,360 (61.5)	4,660 (66)
70	4,810 (58.5)	4,610 (63.5)
75	4,360 (56)	4,560 (60.5)
80	3,910 (53.5)	4,160 (58)
85	3,510 (50.5)	3,660 (55)
90	3,160 (47.5)	3,260 (52)
95	2,860 (44.5)	2,860 (48.5)
100	2,430 (41)	2,430 (45)
105	2,020 (37.5)	2,020 (41.5)
110	1,670 (33)	1,670 (37)

NOTE: ( ) Boom angles are in degrees.

A6-829-011544

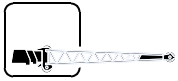

29 ft.  
(8.8 m)



5,787 lbs.  
(2624 kg)



50%  
15' 9" Spread



360°



Feet	0° OFFSET	30° OFFSET
30	9,360 (77.5)	
35	8,960 (75.5)	
40	8,610 (73)	*5,360 (78)
45	7,700 (71)	5,160 (75.5)
50	6,340 (68.5)	4,960 (73.5)
55	5,240 (66)	4,760 (71)
60	4,320 (64)	4,320 (68.5)
65	3,540 (61.5)	3,540 (66)
70	2,880 (58.5)	2,880 (63.5)
75	2,300 (56)	2,300 (60.5)
80	1,800 (53.5)	1,800 (58)
85	1,360 (50.5)	1,360 (55)

NOTE: ( ) Boom angles are in degrees.

A6-829-012409A

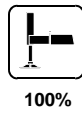
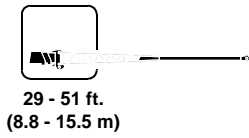

Feet	29 FT. LENGTH		51 FT. LENGTH	
	0° OFFSET	30° OFFSET	0° OFFSET	30° OFFSET
30	9,000 (77.5)			
35	8,600 (75.5)		*5,065 (78)	
40	8,250 (73)	*5,000 (78)	4,900 (76.5)	
45	7,500 (71)	4,800 (75.5)	4,700 (74.5)	
50	6,850 (68.5)	4,600 (73.5)	4,400 (73)	
55	6,250 (66)	4,400 (71)	4,000 (71)	*2,800 (78)
60	5,600 (64)	4,350 (68.5)	3,800 (69)	2,700 (77)
65	5,000 (61.5)	4,300 (66)	3,700 (67)	2,600 (75)
70	4,450 (58.5)	4,250 (63.5)	3,500 (65)	2,500 (72.5)
75	4,000 (56)	4,200 (60.5)	3,400 (62.5)	2,400 (70.5)
80	3,550 (53.5)	3,800 (58)	3,300 (60.5)	2,350 (68)
85	3,150 (50.5)	3,300 (55)	3,100 (58.5)	2,300 (66)
90	2,800 (47.5)	2,860 (52)	2,900 (56)	2,250 (63.5)
95	2,360 (44.5)	2,360 (48.5)	2,700 (54)	2,200 (61)
100	1,910 (41)	1,910 (45)	2,350 (51.5)	2,150 (58.5)
105	1,510 (37.5)	1,510 (41.5)	2,050 (49)	2,150 (55.5)
110	1,150 (33)	1,150 (37)	1,900 (46)	2,040 (52.5)
115			1,680 (43.5)	1,680 (49.5)
120			1,360 (40.5)	1,360 (46.5)
125			1,060 (37)	1,060 (43)

NOTE: ( ) Boom angles are in degrees.  
 \*This capacity is based upon maximum boom angle.

A6-829-011361B

 29 - 51 ft.  
(8.8 - 15.5 m)

 5,787 lbs.  
(2624 kg)

 50%  
15' 9" Spread

 360°

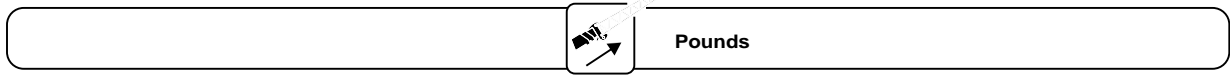

Feet	29 FT. LENGTH		51 FT. LENGTH	
	0° OFFSET	30° OFFSET	0° OFFSET	30° OFFSET
30	9,000 (77.5)			
35	8,600 (75.5)		*5,065 (78)	
40	8,250 (73)	*5,000 (78)	4,900 (76.5)	
45	7,090 (71)	4,800 (75.5)	4,700 (74.5)	
50	5,740 (68.5)	4,600 (73.5)	4,400 (73)	
55	4,630 (66)	4,400 (71)	4,000 (71)	*2,800 (78)
60	3,710 (64)	3,710 (68.5)	3,800 (69)	2,700 (77)
65	2,930 (61.5)	2,930 (66)	3,700 (67)	2,600 (75)
70	2,260 (58.5)	2,260 (63.5)	3,050 (65)	2,500 (72.5)
75	1,690 (56)	1,690 (60.5)	2,490 (62.5)	2,400 (70.5)
80	1,180 (53.5)	1,180 (58)	1,990 (60.5)	1,990 (68)
85			1,550 (58.5)	1,550 (66)
90			1,160 (56)	1,160 (63.5)

NOTE: ( ) Boom angles are in degrees.  
\*This capacity is based upon maximum boom angle.

A6-829-012057A



34 - 105 ft.  
(10.4 - 32.0 m)



5,787 lbs.  
(2624 kg)



Stationary



360°

23.5R25 Tires



Pounds

Feet	34	40	50	*58	60	70	80	90	100
10	31,700 (66)	31,200 (70)							
12	26,900 (62)	26,250 (67)	25,200 (72)	24,400 (74.5)	24,400 (75.5)				
15	19,650 (56)	19,400 (62)	19,050 (68.5)	18,700 (71.5)	18,700 (72.5)				
20	11,850 (44)	11,600 (53)	11,250 (61.5)	11,100 (66)	11,150 (67)	11,950 (71)			
25	7,770 (27)	7,560 (42.5)	7,210 (54.5)	6,820 (60.5)	7,090 (61.5)	7,780 (66.5)	8,480 (70)	8,810 (72.5)	
30		4,980 (28)	4,400 (46.5)	4,110 (54)	4,420 (56)	5,210 (61.5)	5,820 (66)	6,170 (69)	6,170 (71.5)
35			2,580 (37.5)	2,160 (47.5)	2,360 (49.5)	3,420 (57)	3,690 (62)	4,230 (65.5)	4,230 (68.5)
40						1,900 (51.5)	2,100 (57.5)	2,760 (62)	2,760 (65.5)
45								1,600 (58)	1,600 (62)

NOTE: ( ) Boom angles are in degrees.

\*58 ft. boom length is with inner-mid extended and outer-mid & fly retracted.

A6-829-011622

Boom Angle	34	40
0°	6,560 (27.1)	3,840 (33)

NOTE: ( ) Reference radii in feet.

A6-829-011625



34 - 105 ft.  
(10.4 - 32.0 m)



5,787 lbs.  
(2624 kg)



Stationary



Defined Arc  
Over Front  
±6°

23.5R25 Tires



Pounds

Feet	34	40	50	*58	60	70	80	90	100
10	36,850 (66)	34,600 (70)							
12	32,550 (62)	30,650 (67)	27,450 (72)	24,400 (74.5)	24,400 (75.5)				
15	27,400 (56)	25,900 (62)	21,100 (68.5)	21,100 (71.5)	21,100 (72.5)				
20	21,100 (44)	20,050 (53)	18,300 (61.5)	16,900 (66)	16,900 (67)	16,400 (71)	14,450 (74)		
25	15,900 (27)	15,600 (42.5)	14,650 (54.5)	13,650 (60.5)	13,650 (61.5)	13,650 (66.5)	13,000 (70)	11,250 (72.5)	
30		11,150 (28)	9,070 (46.5)	10,250 (54)	10,400 (56)	11,200 (61.5)	11,200 (66)	10,150 (69)	8,090 (71.5)
35			7,760 (37.5)	7,440 (47.5)	7,590 (49.5)	8,260 (57)	8,920 (62)	8,920 (65.5)	7,370 (68.5)
40			5,720 (24.5)	5,450 (39.5)	5,580 (42.5)	6,190 (51.5)	6,800 (57.5)	7,140 (62)	6,660 (65.5)
45				3,970 (30)	4,100 (34)	4,660 (45.5)	5,220 (53)	5,530 (58)	5,840 (62)
50				2,840 (13.5)	2,950 (22)	3,480 (39)	3,990 (48)	4,300 (54)	4,600 (58.5)
55						2,550 (31.5)	3,010 (42.5)	3,320 (50)	3,620 (55)
60						1,800 (20.5)	2,220 (36.5)	2,520 (45.5)	2,820 (51.5)
65							1,550 (29.5)	1,860 (40.5)	2,150 (47.5)
70							1,000 (19.5)	1,300 (34.5)	1,580 (43)
75									1,100 (38.5)

NOTE: ( ) Boom angles are in degrees.

\*58 ft. boom length is with inner-mid extended and outer-mid & fly retracted.

A6-829-011623

Boom Angle	34	40	50	*58	60	70
0°	13,850 (27.1)	9,240 (33)	4,760 (43)	2,690 (50.8)	2,410 (53)	1,410 (63)

NOTE: ( ) Reference radii in feet.

\*58 ft. boom length is with inner-mid extended and outer-mid & fly retracted.

A6-829-011625



34 - 105 ft.  
(10.4 - 32.0 m)



5,787 lbs.  
(2624 kg)



Pick and Carry  
Up to 2.5 MPH



Boom Centered  
Over Front

23.5R25 Tires



Pounds

Feet	34	40	50	*58	60	70	80	90	100
10	38,150 (66)	38,150 (70)							
12	33,350 (62)	33,350 (67)							
15	27,800 (56)	27,700 (62)							
20	21,450 (44)	21,250 (53)	20,900 (61.5)	20,650 (66)	20,850 (67)				
25	15,900 (27)	15,600 (42.5)	15,050 (54.5)	14,600 (60.5)	14,800 (61.5)				
30		11,150 (28)	9,070 (46.5)	10,250 (54)	10,400 (56)	11,200 (61.5)	11,950 (66)		
35			7,760 (37.5)	7,440 (47.5)	7,590 (49.5)	8,260 (57)	8,920 (62)	9,300 (65.5)	9,620 (68.5)
40			5,720 (24.5)	5,450 (39.5)	5,580 (42.5)	6,190 (51.5)	6,800 (57.5)	7,140 (62)	7,450 (65.5)
45				3,970 (30)	4,100 (34)	4,660 (45.5)	5,220 (53)	5,530 (58)	5,840 (62)
50				2,840 (13.5)	2,510 (22)	3,480 (39)	3,990 (48)	4,300 (54)	4,600 (58.5)
55						2,550 (31.5)	3,010 (42.5)	3,320 (50)	3,620 (55)
60						1,800 (20.5)	2,220 (36.5)	2,520 (45.5)	2,820 (51.5)
65							1,550 (29.5)	1,860 (40.5)	2,150 (47.5)
70							1,000 (19.5)	1,300 (34.5)	1,580 (43)
75									1,100 (38.5)

NOTE: ( ) Boom angles are in degrees.

\*58 ft. boom length is with inner-mid extended and outer-mid & fly retracted.

A6-829-011624

Boom Angle	34	40	50	*58	60	70
0°	13,850 (27.1)	9,170 (33)	4,760 (43)	2,690 (50.8)	2,410 (53)	1,410 (63)

NOTE: ( ) Reference radii in feet.

\*58 ft. boom length is with inner-mid extended and outer-mid & fly retracted.

A6-829-011625





34 - 105 ft.  
(10.4 - 32.0 m)



5,787 lbs.  
(2624 kg)



Stationary



360°

26.5 x 25 - 26PR Tires



Pounds

Feet	34	40	50	*58	60	70	80	90	100
10	37,600 (66)	35,550 (69.5)							
12	31,450 (62)	31,200 (66.5)							
15	21,550 (56)	21,200 (61.5)	20,600 (68)						
20	12,950 (44)	12,650 (52.5)	12,200 (61.5)	11,800 (65.5)	11,950 (66.5)				
25	8,510 (27)	8,250 (42)	7,800 (54.5)	7,460 (60)	7,690 (61)	8,760 (66)	8,920 (69)		
30		5,470 (27.5)	5,080 (46.5)	4,780 (54)	4,920 (55.5)	5,530 (61)	6,130 (65)	6,510 (68)	
35			3,230 (37)	2,970 (47)	3,100 (49)	3,680 (56)	4,250 (61)	4,570 (64.5)	4,900 (67.5)
40			1,890 (24)	1,670 (39)	1,790 (42)	2,340 (51)	2,900 (57)	3,180 (61)	3,460 (64.5)
45						1,340 (45)	1,760 (52)	1,760 (57)	1,760 (61)

NOTE: ( ) Boom angles are in degrees.

\*58 ft. boom length is with inner-mid extended and outer-mid & fly retracted.

A6-829-011675

Boom Angle	34	40	50
0°	7,200 (27.1)	4,240 (33)	1,250 (43)

NOTE: ( ) Reference radii in feet.

A6-829-011677



34 - 105 ft.  
(10.4 - 32.0 m)



5,787 lbs.  
(2624 kg)



Stationary



Defined Arc  
Over Front  
±6°

26.5 x 25 - 26PR Tires



Pounds

Feet	34	40	50	*58	60	70	80	90	100
10	38,650 (66)	35,550 (69.5)							
12	36,000 (62)	33,250 (66.5)							
15	32,300 (56)	30,050 (61.5)	23,350 (68)						
20	24,350 (44)	24,200 (52.5)	22,400 (61.5)	20,250 (65.5)	17,500 (66.5)				
25	16,350 (27)	16,150 (42)	15,850 (54.5)	15,600 (60)	15,700 (61)	16,050 (66)	13,050 (69)		
30		11,400 (27.5)	11,150 (46.5)	10,900 (54)	11,000 (55.5)	11,400 (61)	11,800 (65)	8,020 (68)	
35			8,060 (37)	7,880 (47)	7,980 (49)	8,400 (56)	8,810 (61)	8,020 (64.5)	8,420 (67.5)
40			5,890 (24)	5,740 (39)	5,840 (42)	6,270 (51)	6,710 (57)	7,070 (61)	7,430 (64.5)
45				4,150 (29.5)	4,250 (33.5)	4,700 (45)	5,150 (52)	5,490 (57)	5,820 (61)
50				2,920 (13)	3,030 (22)	3,490 (38.5)	3,950 (47.5)	4,270 (53)	4,580 (58)
55						2,580 (31)	3,000 (42)	3,300 (49)	3,600 (54)
60						1,840 (20)	2,220 (36)	2,510 (44.5)	2,790 (50.5)
65							1,580 (28.5)	1,850 (39.5)	2,130 (46.5)
70							1,040 (18.5)	1,300 (33.5)	1,570 (42)
75									1,090 (37.5)

NOTE: ( ) Boom angles are in degrees.

\*58 ft. boom length is with inner-mid extended and outer-mid & fly retracted.

A6-829-011674

Boom Angle	34	40	50	*58	60	70
0°	14,100 (27.1)	9,410 (33)	4,870 (43)	2,760 (50.8)	2,470 (53)	1,460 (63)

NOTE: ( ) Reference radii in feet.

\*58 ft. boom length is with inner-mid extended and outer-mid & fly retracted.

A6-829-011677



34 - 105 ft.  
(10.4 - 32.0 m)



5,787 lbs.  
(2624 kg)



Pick and Carry  
Up to 2.5 MPH



Boom Centered  
Over Front

26.5 x 25 - 26PR Tires



Pounds

Feet	34	40	50	*58	60	70	80	90	100
10	49,200 (66)	49,200 (69.5)							
12	42,950 (62)	42,950 (66.5)							
15	35,850 (56)	35,800 (61.5)	29,300 (68)	29,300 (71)	29,300 (72)				
20	24,350 (44)	24,200 (52.5)	23,950 (61.5)	23,750 (65.5)	23,850 (66.5)				
25	16,350 (27)	16,150 (42)	15,850 (54.5)	15,600 (60)	15,700 (61)	16,050 (66)	16,400 (69)	16,900 (71.5)	
30		11,400 (27.5)	11,150 (46.5)	10,900 (54)	11,000 (55.5)	11,400 (61)	11,800 (65)	12,250 (68)	12,700 (71)
35			8,060 (37)	7,880 (47)	7,980 (49)	8,400 (56)	8,810 (61)	9,210 (64.5)	9,600 (67.5)
40			5,890 (24)	5,740 (39)	5,840 (42)	6,270 (51)	6,710 (57)	7,070 (61)	7,430 (64.5)
45				4,150 (29.5)	4,250 (33.5)	4,700 (45)	5,150 (52)	5,490 (57)	5,820 (61)
50				2,920 (13)	3,030 (22)	3,490 (38.5)	3,950 (47.5)	4,270 (53)	4,580 (58)
55						2,580 (31)	3,000 (42)	3,300 (49)	3,600 (54)
60						1,840 (20)	2,220 (36)	2,510 (44.5)	2,790 (50.5)
65							1,580 (28.5)	1,850 (39.5)	2,130 (46.5)
70							1,040 (18.5)	1,300 (33.5)	1,570 (42)
75									1,090 (37.5)

NOTE: ( ) Boom angles are in degrees.

\*58 ft. boom length is with inner-mid extended and outer-mid & fly retracted.

A6-829-011676

Boom Angle	34	40	50	*58	60	70
0°	14,100 (27.1)	9,410 (33)	4,870 (43)	2,760 (50.8)	2,470 (53)	1,460 (63)

NOTE: ( ) Reference radii in feet.

\*58 ft. boom length is with inner-mid extended and outer-mid & fly retracted.

A6-829-011677

**NOTES:**

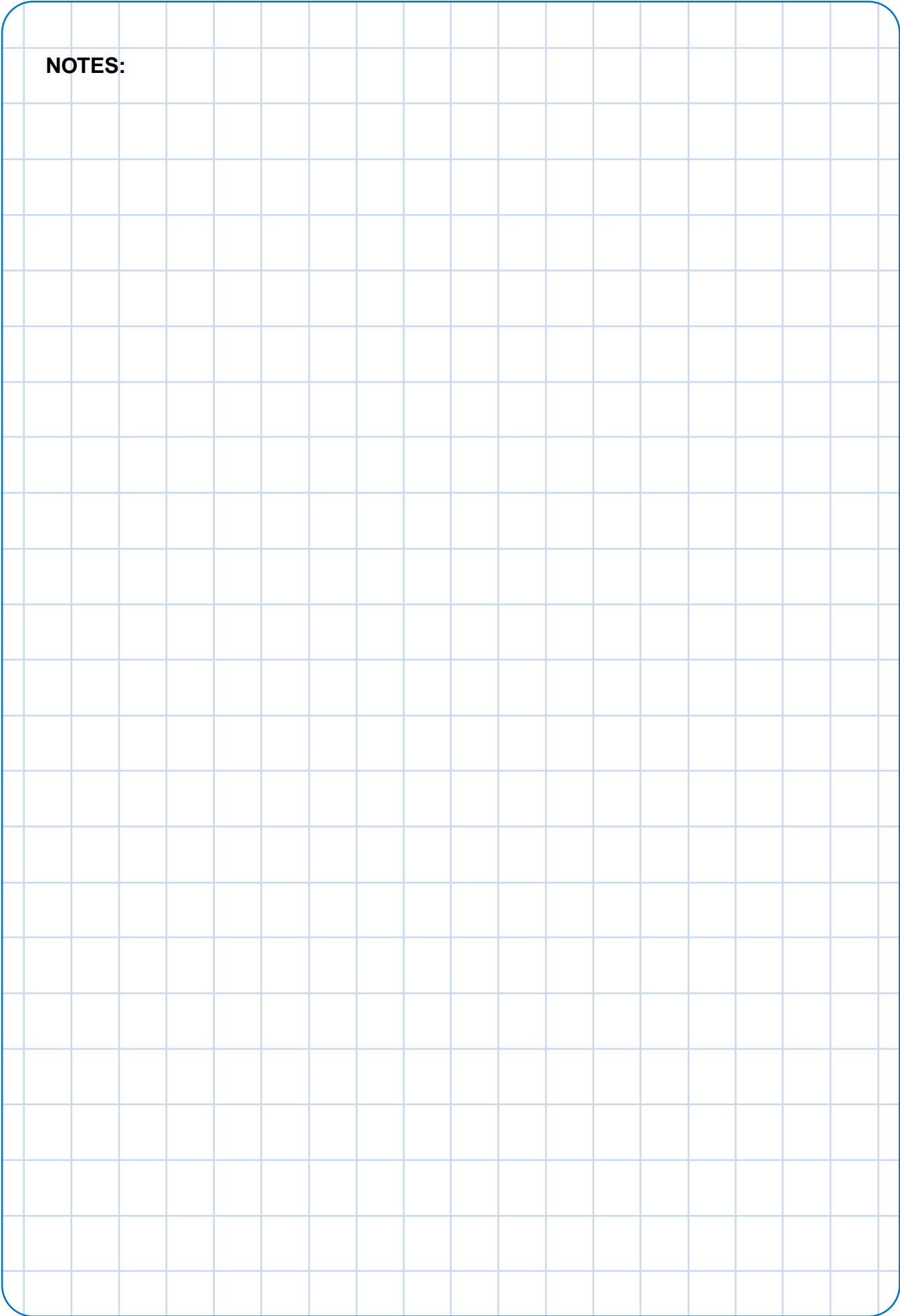





































# Rated Lifting Capacities

## IMPORTANT NOTES:

**WARNING: THIS CHART IS ONLY A GUIDE.**  
**The notes below are for illustration only and should not be relied upon to operate the crane.**  
**The individual crane's load chart, operating instructions and other instruction plates must be read and understood prior to operating the crane.**

1. All rated loads meet ANSI/ASME B30.5, Mobile and Locomotive Cranes. Testing and development were performed to SAEJ1063, Cantilevered Boom Crane Structures - Method of Test and SAEJ765 Crane Stability Test Code.
2. Rated loads include the weight of hookblock, slings and auxiliary lifting devices and their weights shall be subtracted from the listed rating to obtain the net load to be lifted. When more than the minimum required hoist reeving is used, the additional rope weight shall be considered part of the load to be handled.
3. Defined Arc  $\pm 6^\circ$  on either side of longitudinal centerline of machine.
4. Capacities appearing above the bold line are based on structural strength and tipping should not be relied upon as a capacity limitation.
5. The machine shall be leveled on a firm supporting surface. Depending on the nature of the supporting surface, it may be necessary to have structural supports under the outrigger floats or tires to spread the load to a larger bearing surface.
6. When either boom length or radius or both are between values listed, the smallest load shown at either the next larger radius or next longer or shorter boom length shall be used.
7. Tires shall be inflated to the recommended pressure before lifting on rubber.
8. For outrigger operation, outriggers shall be properly extended with tires raised free of crane weight before operating the boom or lifting loads.

# Symbols Glossary

	Frame		Steering
	Outriggers		Transmission
	Outrigger Controls		Axles
	Engine		Brakes
	Fuel Tank Capacity		Tires
	Electrical System		Suspension
	Drive		Rotation
	Lights		Boom Elevation
	Cab		Swing
	Boom		Counterweight
	Fixed Swingaway		Oil
	Tele-Swingaway		Hydraulic System
	Jib		Hoist
	Boom Nose		Radius
	Boom Extension		Boom Length
	Speed		Hookblock
	Grade		Gear
	Lattice Extension		Luffing Jib

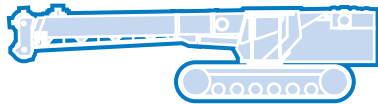
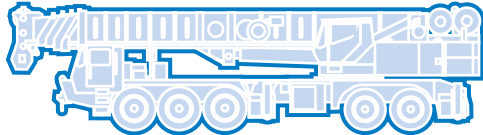
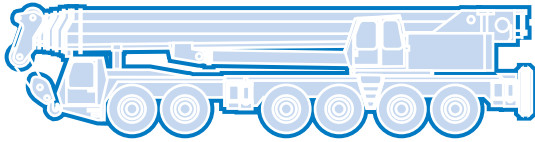
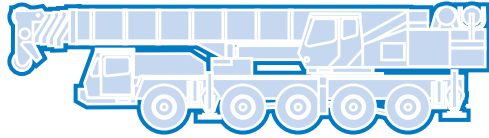

**Grove Worldwide – World Headquarters**

**Grove North America**  
1565 Buchanan Trail East  
P.O. Box 21  
Shady Grove, Pennsylvania 17256, U.S.A.  
Tel: [Int + 1] (717) 597-8121  
Fax: [Int + 1] (717) 597-4062  
Western Hemisphere, Asia/Pacific

**Grove Europe Limited\***

Sunderland SR4 6TT, England  
Tel: [Int + 44] 191 565-6281  
Fax: [Int + 44] 191 564-0442  
Europe, Africa, Middle East

**Grove Europe Limited\***

P.O. Box No. 268  
4A Kimber Road  
Abingdon, Oxfordshire, OX141SG  
Tel: [Int + 44] 1235 55-3184  
Fax: [Int + 44] 1235 55-3218

\*Grove Europe Limited, Registered in England,  
Number 1845128, Registered office, Crown Works,  
Pallion, Sunderland, Tyne & Wear, England SR4 6TT

**Deutsche Grove GmbH**

**Sales and Service**  
Helmholtzstrasse 12, Postfach 5026  
D-40750 Langenfeld, Germany  
Tel: [Int + 49] (2173) 8909-0  
Fax: [Int + 49] (2173) 8909-30

**Wilhelmshaven Works**

Industriegelände West, Postfach 1853  
D-26358 Wilhelmshaven, Germany  
Tel: [Int + 49] (4421) 294-0  
Fax: [Int + 49] (4421) 294-301

**Grove France S.A.**

16, chaussée Jules-César, 95520 OSNY  
B.P. 203, 95523 CERGY PONTOISE CEDEX  
France  
Tel: [Int + 33] (1) 30313150  
Int: [Int + 33] (1) 30386085

**Grove Asia/Pacific - Regional Office**

171 Chin Swee Road  
#06-01 San Centre  
Singapore 0316  
Tel: [Int + 65] 536-6112  
Fax: [Int + 65] 536-6119  
Asia/Pacific, Near East

**Grove China - Representative Office**

Beijing Suite 6074  
No. 33 East Chang An Avenue  
Beijing, 100004, China  
Tel: [Int + 86] (10) 513-7766  
Fax: [Int + 86] (10) 513-7307

**Grove Product Support**

Western Hemisphere, Asia/Pacific  
1086 Wayne Avenue  
Chambersburg, Pennsylvania USA  
Tel: [Int + 1] (717) 263-5100  
Fax: [Int + 1] (717) 267-0404

Europe, Africa, Middle East  
Sunderland SR4 6TT, England  
Tel: [Int + 44] 191 565-6281  
Parts Fax: [Int + 44] 191 510-9242  
Service Fax: [Int + 44] 191 510-9560

<http://www.grovetworldwide.com>

Constant improvement and engineering progress make it necessary that we reserve the right to make specification, equipment, and price changes without notice. Illustrations shown may include optional equipment and accessories and may not include all standard equipment.

Distributed By: